

1
8
1



Mixtard® 30 InnoLet®

Read all of this leaflet carefully before you start using your insulin. Keep this leaflet. You may need to read it again.

If you have further questions, please ask your doctor or your pharmacist. This medicine has been prescribed for you personally and you must not pass it on to others. It may harm them, even if their symptoms are the same as yours.

This side of the leaflet:

- 1 What Mixtard® is and what it is used for
- 2 Before you use Mixtard®
- 3 How to use Mixtard®
- 4 What to do in an emergency
- 5 Possible side effects
- 6 Storing Mixtard®

Overleaf: How to use your InnoLet®

Mixtard® 30 InnoLet® 100 IU/ml Suspension for injection in a pre-filled pen
Insulin human, rDNA.
The active substance is insulin human made by recombinant biotechnology (30% as soluble insulin and 70% as isophane insulin).
1 ml contains 100 IU of insulin human.
1 pre-filled pen contains 3 ml equivalent to 300 IU.
The other ingredients are zinc chloride, glycerol, metacresol, phenol, disodium phosphate dihydrate, sodium hydroxide, hydrochloric acid, protamine sulphate and water for injections.
The suspension for injection comes as a cloudy, white, aqueous suspension in packs of 1, 5 or 10 pre-filled pens of 3 ml (not all packs may be marketed).
The marketing authorisation holder and manufacturer is
Novo Nordisk A/S,
Novo Allé, DK-2880 Bagsværd, Denmark.

8-9603-01-002-2

RA Labelling & Graphics

Insert: 520x200-003
Current 2.0

HI-CP - Suspension

**Colour: PMS 280C +
PMS 285C**

1 What Mixtard® is and what it is used for

Mixtard® is human insulin to treat diabetes. It comes in a 3 ml pre-filled pen (called InnoLet® - see overleaf for detailed instructions).

Mixtard is a mixture of fast-acting insulin and long-acting insulin. This means that it will start to lower your blood sugar about half an hour after you take it, and the effect will last for approximately 24 hours.

2 Before you use Mixtard®

Do not use Mixtard

- ▶ **If you feel a hypo** coming on (a hypo is short for a hypoglycaemic reaction and is symptoms of low blood sugar). See 4 *What to do in an emergency*, for more about hypos
- ▶ **If you are allergic (hypersensitive)** to this insulin product, metacresol or any of the other ingredients (see box, below left). Look out for the signs of allergy in 5 *Possible side effects*.

Take special care with Mixtard

- ▶ **If you have trouble** with your kidneys or liver, or with your adrenal, pituitary or thyroid glands
- ▶ **If you are drinking alcohol:** watch for signs of a hypo and never drink alcohol on an empty stomach
- ▶ **If you are exercising** more than usual or if you want to change your usual diet
- ▶ **If you are ill:** carry on taking your insulin
- ▶ **If you are going abroad:** travelling over time zones may affect your insulin needs and the timing of your injections
- ▶ **If you are pregnant, planning a pregnancy or breast-feeding:** please contact your doctor for advice
- ▶ **If you drive or use tools or machines:** watch out for signs of a hypo. Your ability to concentrate or to react will be less during a hypo. Never drive or use machinery if you feel a hypo coming on. Discuss with your doctor whether you can drive or use machines at all, if you have a lot of hypos or if you find it hard to recognise hypos.

Using other medicines

Many medicines affect the way glucose works in your body and they may influence your insulin dose. Listed below are the most common medicines which may affect your insulin treatment. Talk to your doctor or pharmacist if you take or have recently taken any other medicines, even those not prescribed.

Your need for insulin may change if you also take: oral antidiabetic products; monoamine oxidase inhibitors (MAOI); beta-blockers; ACE-inhibitors; acetylsalicylic acid; thiazides; glucocorticoids; thyroid hormone therapy; beta-sympathomimetics; growth hormone; danazol; octreotide and lanreotide.

3 How to use Mixtard®

Talk about your insulin needs with your doctor and diabetes nurse. Follow their advice carefully. This leaflet is a general guide.

If your doctor has switched you from one type or brand of insulin to another, your dose may have to be adjusted by your doctor.
Eat a meal or snack containing carbohydrates within 30 minutes of the injection.
It is recommended that you measure your blood glucose regularly.

Injecting insulin

See overleaf for detailed instructions.

Before using Mixtard

- ▶ **Check the label** to make sure it is the right type of insulin.

Do not use Mixtard

- ▶ **In insulin infusion pumps**
- ▶ **If InnoLet is dropped, damaged or crushed** there is a risk of leakage of insulin
- ▶ **If it hasn't been stored correctly** or been frozen (see 6 *Storing Mixtard*)
- ▶ **If it's not uniformly white and cloudy** when it's mixed.

Mixtard is for injection under the skin (subcutaneously). Never inject your insulin directly into a vein or muscle. Always vary the sites you inject, to avoid lumps (see 5 *Possible side effects*). The best places to give yourself an injection are: the front of your waist (abdomen); your buttocks; the front of your thighs or upper arms. Your insulin will work more quickly if you inject around the waist.

4 What to do in an emergency

If you get a hypo

A hypo means your blood sugar level is too low.

The warning signs of a hypo may come on suddenly and can include: cold sweat; cool pale skin; headache; rapid heart beat; feeling sick; feeling very hungry; temporary changes in vision; drowsiness; unusual tiredness and weakness; nervousness or tremor; feeling anxious; feeling confused; difficulty in concentrating.

If you get any of these signs: eat glucose tablets or a high sugar snack (sweets, biscuits, fruit juice), then rest. **Don't take any insulin** if you feel a hypo coming on.

Carry glucose tablets, sweets, biscuits or fruit juice with you, just in case.

Tell your relatives, friends and close colleagues that if you pass out (become unconscious), they must: turn you on your side and seek medical advice straight away. They must not give you any food or drink as it could choke you.

▶ **If severe hypoglycaemia** is not treated, it can cause brain damage (temporary or permanent) and even death

▶ **If you have a hypo** that makes you pass out, or a lot of hypos, talk to your doctor. The amount or timing of insulin, food or exercise may need to be adjusted.

Using glucagon

You may recover more quickly from unconsciousness with an injection of the hormone glucagon by someone who knows how to use it. If you are given glucagon you will need glucose or a sugary snack as soon as you are conscious. If you do not respond to glucagon treatment, you will have to be treated in a hospital. Seek medical advice after an injection of glucagon; you need to find the reason for your hypo to avoid getting more.

Causes of a hypo

You get a hypo if your blood sugar gets too low. This might happen:

- If you take too much insulin
- If you eat too little or miss a meal
- If you exercise more than usual.

If your blood sugar gets too high

Your blood sugar may get too high (this is called hyperglycaemia).

The warning signs appear gradually. They include: increased urination; feeling thirsty; losing your appetite; feeling sick (nausea or vomiting); feeling drowsy or tired; flushed, dry skin; dry mouth and a fruity (acetone) smell of the breath.

If you get any of these signs: test your blood sugar level; test your urine for ketones if you can; then seek medical advice straight away. These may be signs of a very serious condition called diabetic ketoacidosis. If you don't treat it, this could lead to diabetic coma and death.

Causes of hyperglycaemia

- Having forgotten to take your insulin
- Repeatedly taking less insulin than you need
- An infection or a fever
- Eating more than usual
- Less exercise than usual.

5 Possible side effects

Like all medicines, Mixtard can have side effects. Mixtard may cause hypoglycaemia (low blood sugar). See the advice in 4 *What to do in an emergency*.

Side effects reported uncommonly

(less than 1 in 100)

Changes at the injection site. If you inject yourself too often at the same site, lumps may develop underneath. In addition, you may experience pain and bruising at the injection site. Prevent this by choosing different injection sites each time within the same region.

Signs of allergy. Reactions (redness, swelling, itching) at the injection site may occur (local allergic reactions). These usually disappear after a few weeks of taking your insulin. If they do not disappear, see your doctor.

Seek medical advice immediately:

- If signs of allergy spread to other parts of the body, or
- If you suddenly feel unwell and you: start sweating; start being sick (vomiting); have difficulties in breathing; have a rapid heart beat; feel dizzy, feel like fainting.

You may have a very rare serious allergic reaction to Mixtard or one of its ingredients (called a systemic allergic

reaction). See also warning in 2 *Before you use Mixtard*.

Diabetic retinopathy (eye background changes). If you have diabetic retinopathy and your blood glucose levels improve very fast, the retinopathy may get worse. Ask your doctor about this.

Swollen joints. When you start taking insulin, water retention may cause swelling around your ankles and other joints. This soon disappears.

Painful neuropathy (nerve related pain). If your blood glucose levels improve very fast it may cause a burning, tingling or electric pain. This is called acute painful neuropathy and it usually disappears. If it does not disappear, see your doctor.

Side effects reported very rarely

(less than 1 in 10,000)

Vision problems. When you first start your treatment, it may disturb your vision, but the reaction usually disappears.

If you notice any side effects also those not mentioned in this leaflet, please inform your doctor or pharmacist.

6 Storing Mixtard®

Keep out of the reach and sight of children.

Mixtard 30 InnoLet that is not being used is to be stored in a refrigerator (2°C - 8°C). Do not freeze.

Mixtard 30 InnoLet that is being used, about to be used or carried as a spare is not to be kept in a refrigerator. You can carry it with you and keep it at room temperature (not above 30°C) for up to 6 weeks.

Always keep the pen cap on your InnoLet when you're not using it in order to protect it from light. Mixtard must be protected from excessive heat and sunlight. Do not use Mixtard after the expiry date stated on the label and the carton.

Now turn over for information on how to use your InnoLet.

Leaflet last approved August 2004.

proof Novo Nordisk A/S

Carried out:

Approved Graphics:

Approved Aff/RO:

1

2

Approved Labelling:

1

2

New proof desired

Approved

Pdf desired

Mixtard®, InnoLet® and NovoFine®
are trademarks owned by
Novo Nordisk A/S, Denmark

© 2000/2005

Novo Nordisk A/S



Information on how to use Mixtard® 30 InnoLet®
Please read the following instructions carefully before using your Mixtard 30 InnoLet.

Introduction

Mixtard® 30 InnoLet® is a simple, compact pre-filled pen able to deliver 1 to 50 units in increments of 1 unit. Mixtard 30 InnoLet is designed to be used with NovoFine® needles of 8 mm or shorter in length. Look for an **S** on the needle box. The **S** stands for short cap. As a precautionary measure, always carry a spare insulin delivery device in case your InnoLet is lost or damaged.

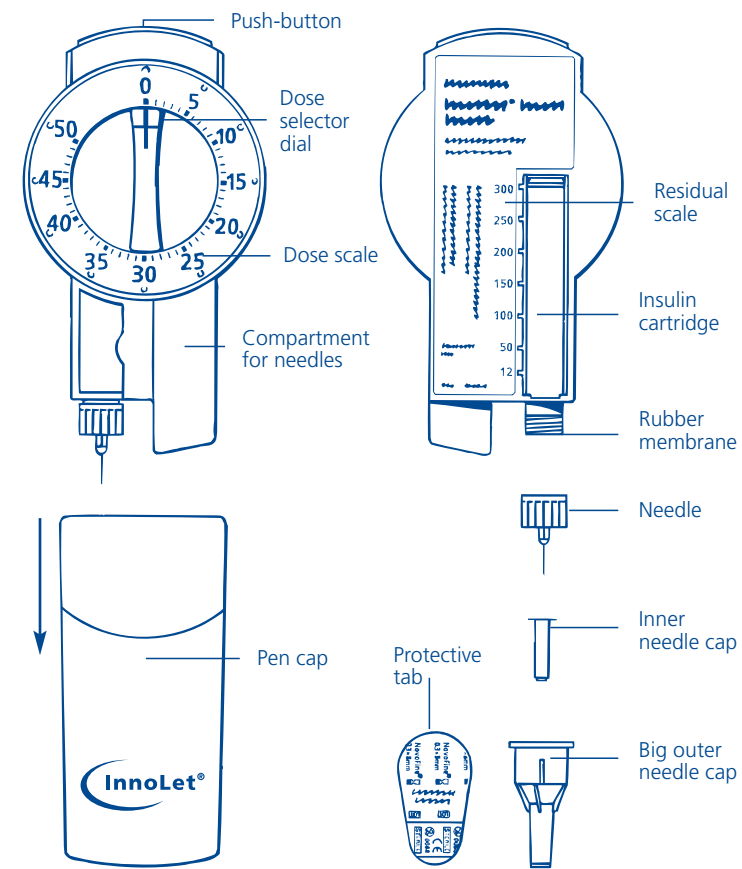

Preparing for injection

Check the label to make sure that your Mixtard 30 InnoLet contains the correct type of insulin. Take off the pen cap (as shown by the arrow). Mixing is easier when the insulin has reached room temperature.

Suspending the insulin

Before every injection:

- **Check there are at least 12 units** of insulin left in the cartridge to allow even mixing. If there are less than 12 units left, use a new Mixtard 30 InnoLet.
- **Move the pen up and down** between positions **A** and **B** and back so that the glass ball moves from one end of the cartridge to the other (picture **1A**) at least 20 times. Repeat this movement at least 10 times before each injection. The movement must always be repeated until the liquid appears uniformly white and cloudy.
- **After mixing, complete all of the following stages of injection without delay.**

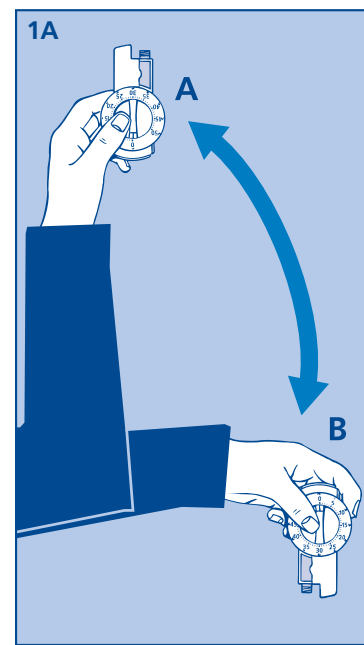

Attaching the needle

- **Disinfect the rubber membrane** with a medicinal swab
- **Remove the protective tab** from a NovoFine **S** needle
- **Screw the needle straight and tightly** onto Mixtard 30 InnoLet (picture **1B**)
- **Pull off the big outer needle cap and the inner needle cap.** You may want to store the big outer needle cap in the compartment.

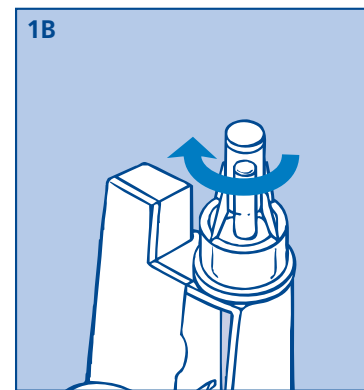

Priming to expel air

Small amounts of air may collect in the needle and cartridge during normal use. To avoid injection of air and ensure proper dosing:

- **Dial 2 units** by turning the dose selector clockwise
- **Hold Mixtard 30 InnoLet with the needle upwards and tap the cartridge gently** with your finger a few times to make any air bubbles collect at the top of the cartridge (picture **1C**)
- **Keeping the needle upwards, press the push-button** and the dose selector returns to zero
- **A drop of insulin must appear at the needle tip.** If not, change the needle and repeat the procedure no more than 6 times.

If a drop of insulin still does not appear, the device is defective and must not be used.

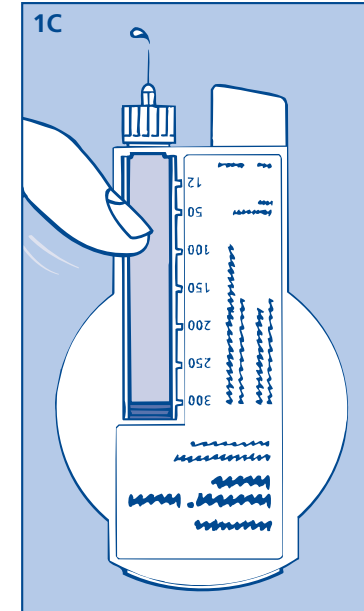

Setting the dose

- **Always check that the push-button is fully depressed and the dose selector is set to zero**
- **Dial the number of units required** by turning the dose selector clockwise (picture **2**). Do not use the residual scale to measure your dose of insulin
- **You will hear a click for every single unit dialled.** The dose can be corrected by turning the dial either way.

You cannot set a dose larger than the number of units remaining in the cartridge.

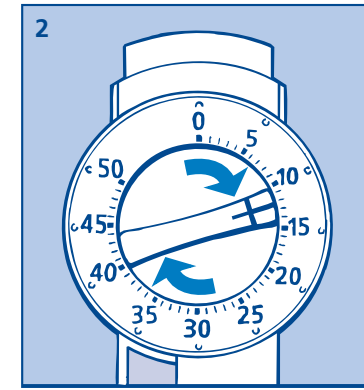

Injecting the insulin

- **Insert the needle into your skin.** Use the injection technique advised by your doctor
- **Deliver the dose by pressing the push-button fully down** (picture **3**). You will hear clicks as the dose selector returns to zero
- **After the injection, the needle must remain under the skin for at least 6 seconds** to ensure that the full dose has been delivered
- **Make sure not to block the dose selector while injecting**, as the dose selector must be allowed to return to zero when you press the push-button
- **Remove the needle after each injection.**

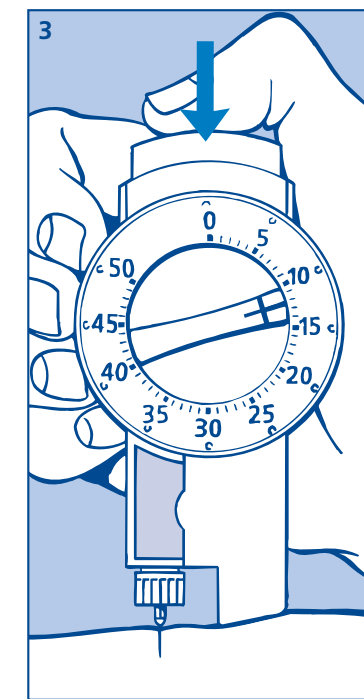

Removing the needle

- **Replace the big outer needle cap and unscrew the needle** (picture **4**). **Dispose of it carefully.**

Use a new needle for each injection. Remove the needle after each injection. Otherwise, the liquid may leak out when the temperature changes, and the strength of the insulin may change. Health care professionals, relatives and other carers must follow general precautionary measures for removal and disposal of needles to eliminate the risk of unintended needle penetration. Dispose of your used Mixtard 30 InnoLet carefully without the needle attached.

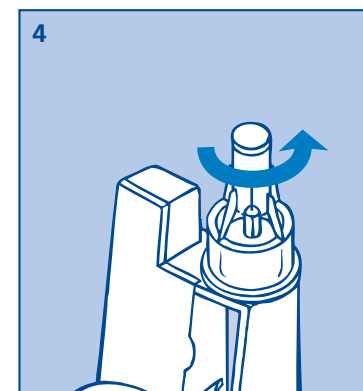

Maintenance

Your Mixtard 30 InnoLet is designed to work accurately and safely. It must be handled with care. Do not refill Mixtard 30 InnoLet. You can clean your Mixtard 30 InnoLet by wiping it with a medicinal swab. Do not soak it, wash or lubricate it. This may damage the mechanism.